

CBSE | DEPARTMENT OF SKILL EDUCATION

CURRICULUM FOR SESSION 2021-2022

MULTI SKILL FOUNDATION COURSE (CODE NO- 416)

JOB ROLE: MULTI SKILL ASSISTANT TECHNICIAN

CLASS – IX & X

INTRODUCTION:

Multi Skill Foundation Course (MSFC) - The Multi-Skill Foundation Course curriculum is broken down into coherent parts known as Units. Each unit is further broken down into knowledge and skills on the basis of which evidence is to be provided by the learner and the evaluation is to be done by the teacher or trainer. "Multi-Skill Foundation Course" (MSFC) is revised version of pre-vocational program V-1 "Introduction to Basic Technology", being implemented in Maharashtra since 1987.

Nature of the course: The course is divided into four modules: Workshop & Engineering Techniques, Energy & Environment, Gardening, Nursery and Agriculture Techniques, Food Processing Techniques (9th class) / Personal Health & Hygiene (10th class)

The Engineering (material-joining, shaping and otherwise fabricating into usable articles, including housing) and Energy-Environment (application of electricity, non-conventional energy and systems, processes, and tools- computers, management techniques). It also covers basics of engineering and project management. Home-Health (related to human life), and Agriculture (Plant and animal kingdom) give the skills related to clothing food and health of human beings. Agriculture covers the skill needed for production and preservation of food of both plant and animal origin, including care of plants/crops.

BENEFITS:

1. Multi-skill nature of the program helps students to select choice of his/her future specialization. He/she is a jack of all skills and will be enabled to select one for his/her future.
2. Most importantly, the variety of experiences students gets during "Multi-Skill Foundation" training will stimulate their intellect. Multidisciplinary knowledge will help him to appreciate underlying principles and processes and apply that knowledge in new areas.
3. All ground level work activities need multi skills. For e.g. farmer need to have basic knowledge of electricity, food processing, agriculture and even construction. This helps him to become self-reliant under adverse conditions. A fabricator, who gets orders for construction of poultry, will be in better position to serve his client if he knows basics of poultry. This helps to develop such kinds of interdisciplinary approaches with appreciation for other fields.

COURSE OBJECTIVES:

On completion of the course, student should be able to:

- Apply effective oral and written communication skills to interact with people and customers;
- Demonstrate the knowledge of constructional details and working of soak pit, and why wet and dry garbage needs to be separated.
- Demonstrate knowledge of land preparation / pot filling for cultivating a crop either on a plot of land / terrace garden / in a pot

- Select healthy seeds for sowing; demonstrate the knowledge of basic seeds treatment.
- Demonstrate growing of one vegetable crop on a small plot / kitchen garden / terrace garden.
- Understand different breeds of animals – indigenous and breed variety.
- Determine age of the animal and their feed requirements.
- Demonstrate ability to estimate feed requirement, yield of the animal and its well-being (for any common animal/pet in the local area e.g. sheep, goat, poultry bird, cow/buffalo)
- Demonstrate soldering of basic electronics components using soldering iron.
- Maintenance of lead acid batteries, measuring its specific gravity.
- To demonstrate understanding of electricity consumption of various household electric fittings and kitchen equipment's and calculate monthly electricity unit's usage by a family.
- Demonstrate knowledge of electricity saving measures
- Demonstrate measurement capability using different measuring instruments such as meter tape, Vernier Calliper, and screw Gauge. Able to measure different jobs in the surrounding environment viz. furniture, building dimensions etc.
- Identify tools and equipment used in the Engineering workshop section.
- Demonstrate safe use and application of workshop tools and equipment.
- Install simple pipe line connection using PVC pipes, connectors and other plumbing accessories;
- Identify various tools and equipment required in the section and their usage.
- Demonstrate the understanding of safety measures required to be taken while using electrical and electronic tools and equipment.
- Perform various types of joints for joining electrical wires.
- Demonstrate basic knowledge of cooking and baking using a recipe with basic kitchen equipment.
- Demonstrate the knowledge of preserving foods using simple preservation techniques.
- Demonstrate and maintain personal hygiene & hygiene of cooking area
- Demonstrate safety measures to be observed in the kitchen.
- Understand concept of calories, calories in the locally available food, calories requirement of an adult and child.
- To be able to use & maintain different stoves viz. wick / pressure stove / LPG / smokeless Chula

CURRICULUM:

This course is a planned sequence of instructions consisting of Units meant for developing employability and Skills competencies of students of Class IX and X opting for Skills subject along with other subjects.

The unit-wise distribution of hours and marks for Class 9 & 10 is as follows:

MULTI SKILL FOUNDATION COURSE (CODE NO- 416)**CLASS – IX (SESSION 2021-2022)**

Total Marks: 100 (Theory-50 + Practical-50)

	UNITS		NO. OF HOURS for Theory and Practical 200		MAX. MARKS for Theory and Practical 100
Part A	TERM	Employability Skills			
	Term 1	Unit 1 : Communication Skills-I	10		5
		Unit 2 : Self-Management Skills-I	10		
		Unit 3 : ICT Skills-I	10		
	Term 2	Unit 4 : Entrepreneurial Skills-I	15		5
		Unit 5 : Green Skills-I	05		
		Total	50	10	
Part B	Subject Specific Skills		Theory (In Hours)	Practical (In Hours)	Marks
	Term 1	Unit 1: Workshop and Engineering Techniques	20	10	20
		Unit 2: Energy and Environment	17	10	
	Term 2	Unit 2: Energy and Environment	18	10	20
		Unit 3: Gardening, Nursery & Agriculture Techniques	15	15	
		Unit 4: Food Processing Techniques	15	10	
			Total	95	55
Part C	Practical Work				
		Practical Examination			15
		Project			15
		Viva Voce			10
		Total			40
Part D	Student Portfolio				
		Practical File/ Student Portfolio	10		10
			Total		10
		GRAND TOTAL	200		100

MULTI SKILL FOUNDATION COURSE (CODE NO- 416)**CLASS – X (SESSION 2021-2022)**

Total Marks: 100 (Theory-50 + Practical-50)

	TERM	UNITS	NO. OF HOURS for Theory and Practical 200		MAX. MARKS for Theory and Practical 100	
Part A	Employability Skills					
	Term 1	Unit 1 : Communication Skills-II	10		5	
		Unit 2 : Self-Management Skills-II	10			
		Unit 3 : ICT Skills-II	10			
	Term 2	Unit 4 : Entrepreneurial Skills-II	15		5	
		Unit 5 : Green Skills-II	05			
		Total	50		10	
Part B	Subject Specific Skills			Theory (In Hours)	Practical (In Hours)	
	Term 1	Unit 1: Workshop and Engineering Techniques	35	15	20	
		Unit 2: Energy and Environment	15	8		
	Term 2	Unit 2: Energy and Environment	15	7	20	
		Unit 3: Gardening, Nursery & Agriculture Techniques	15	10		
		Unit 4: Personal Health and Hygiene	15	10		
			Total	95	55	40
Part C	Practical Work					
		Practical Examination			15	
		Project			15	
		Viva Voce			10	
		Total			40	
Part D	Student Portfolio					
		Practical File/ Student Portfolio	10		10	
			Total			10
		GRAND TOTAL	200		100	

DETAILED CURRICULUM/TOPICS FOR CLASS IX:

Part-A: EMPLOYABILITY SKILLS

S. No.	Units	Duration in Hours
1.	Unit 1: Communication Skills-I	10
2.	Unit 2: Self-management Skills-I	10
3.	Unit 3: Basic Information and Communication Technology Skills-I	10
4.	Unit 4: Entrepreneurial Skills-I	15
5.	Unit 5: Green Skills-I	05
TOTAL		50

NOTE: For Detailed Curriculum/ Topics to be covered under Part A: Employability Skills can be downloaded from CBSE website.

Part-B – SUBJECT SPECIFIC SKILLS

- Unit 1: Workshop and Engineering Techniques
- Unit 2: Energy and Environment
- Unit 3: Gardening, Nursery & Agriculture Techniques
- Unit 4: Food Processing Techniques

UNIT 1 – WORKSHOP & ENGINEERING SECTION

LEARNING OUTCOMES	THEORY	PRACTICAL
1. Carry out measurement using instruments such as meter tape, Vernier caliper, and screw gauge, spring balance.	1. Describe the reason of selecting particular measuring instrument for certain task.	1. Selection of measuring instrument for given task. 2. To read the reading properly.
2. Recognize basic workshop tools and equipment and demonstrate their safe use	1. Describe the main features and purpose of workshop tools and equipment like screw driver, hammer, chisel, saw, spanners, wrench, etc. 2. Describe the safety precautions to be followed while using the tools.	1. Identification of workshop tools and equipment like screw driver, hammer, chisel, saw, spanners, etc. 2. Demonstration of safety gadgets 3. Cleanliness of the work area before and after
3. Prepare a simple wooden object like pad for writing/ newspaper holder, display	1. Describe advantages and disadvantages of Wood	1. Demonstrate the Marking of job 2. Demonstrate and perform the Sharpening of tools

LEARNING OUTCOMES	THEORY	PRACTICAL
board, stool, electric board etc.	2. Describe methods to prevent pest attack on wood	3. Demonstrate and perform Drilling hole in wood/plywood 4. Demonstrate and perform Fixing sun mica on plywood surface 5. Demonstrate and perform Finishing and polishing
4. Prepare a "Garbage Scoop" or "GI Sheet Box" (or any other article of need viz funnel, electric meter box, rain gauge) with GI sheet using soldering method	Describe safety precautions to be followed while preparing the article	1. Demonstrate and perform the article with given GI sheet according to given drawing/dimension using soldering method and following the relevant safety precautions 2. Draw a flow chart of this activity.
5. Carry out drilling of MS flat, Threading and tapping on a MS rod.	1. Describe use of thread 2. Describe safety precautions to be followed while drilling.	1. Perform Filing of rod and flat 2. Demonstrate and perform Carry of Marking for Drilling 3. Selection of appropriate tap, die and drill 4. Perform threading and tapping
6. Make any one of the following objects: Shoe stand, Candle stand, Hanger, Garbage collector, Tin box, Bangle stand using T-fillet joint, Open corner joint, Single V-butt joint	1. Describe safety precautions for making object 2. Describe the various types of material that can be used for making objects	1. Demonstrate and perform the design and drawing for the object 2. Perform the necessary measurement and marking as per the specifications 3. Students will observe & describe the process of welding carried out by the trainer for making the object as per the design & specification. (Students are not expected to carry out the process of welding but only observe by following due safety precautions) 4. Perform and Follow safety precautions 5. Demonstrate the use of personal protective clothing and equipment 6. Perform cleaning the work area before and after the task 7. Perform calculation of the cost of the article prepared
7. Identify building materials and describe their uses. Also identify tools required in construction work	1. Describe various type of building materials and its applications (like iron, wood, aluminum, cement, sand, concrete, granite, marble, paint,	1. Identification of various types of building materials

LEARNING OUTCOMES	THEORY	PRACTICAL
	chemicals, stone, cement composites, glass, plastics etc.) 2. Identify various types of construction tools and equipment and their purpose.	
8. Identify the various types of walls	1. Describe the chief characteristics of various types of walls (partition walls, exterior boundary walls, separation walls, retaining walls, shared walls, portable walls, dry stone walls, etc.)	1. Identification of different types of wall (building walls, exterior boundary walls and retaining walls)
9. Arrange bricks in different types of bond	1. Describe different types of bond and their application 2. Describe safety precautions while handling and laying of the brick	1. Demonstration to arrange bricks in different bonds (Stretcher bond, English bond, Flemish bond, Header bond, Stack bond). The bricks are arranged in the required formation uniformly for each of the bond up to 1 meter 2. Perform task of laying brick with mortar 3. Demonstrate and perform the use of spirit level, water tube and plumb bomb.
10. Make a simple pipe line by using plumbing accessories. Make sure that there is at least one joint.	1. Describe safety precautions while using piping material 2. Describe various components of plumbing accessories such as elbow bend, coupling, cock, primer, connector, etc.	1. Demonstrate and perform the process Cut PVC pipe with a hand saw 2. Perform the process to join PVC pipes with a connector & solution

UNIT 2 – ENERGY & ENVIRONMENT SECTION

LEARNING OUTCOMES	THEORY	PRACTICAL
1. Identify electrical tools and equipment, their usage and the safety measures to be taken	1. Read the symbols and describe their usage 2. Describe the purpose of symbols.	1. Perform match the symbols and description 2. Identification of various types of electrical tools and equipment.

LEARNING OUTCOMES	THEORY	PRACTICAL
while using them	3. Describe health and safety risks and procedures involved in the use of electrical tools, equipment and materials	3. Follows the manufacture's instruction for use. Clean the work area before and after the task
2. Identify the various types of wire, cable and switches	1. State the purpose of different types of wire, cable and switches.	1. Perform identification process to different types of wire, cable and switches.
3. Demonstrate the use of Standard/ American wire gauge	1. Describe the use of Standard/ American wire Gauge	1. Demonstrate the use of wire gauge for measuring the diameter of the wire
4. Perform various types of joints used for joining electrical wires	1. Recognize the type of joints 2. Describe the purpose of using the following types of joint: <ul style="list-style-type: none"> • Simple Twist Joint • Straight Joint 	1. Demonstrate the use of wire stripping hand tools for stripping wire 2. Demonstrate knife stripping of wire 3. Demonstrate the following for joining electrical wires: <ul style="list-style-type: none"> • Simple Twist Joint • Straight Joint 4. Demonstrate the use of plastic electrical tape 5. Perform cleaning the work area before and after the task
5. Prepare a simple electrical circuit	1. Explain the meaning of various terms used in simple circuit such as electrical potential difference/ voltage, conductive path, electrical resistance potential difference, transistor, conventional current, direct current, capacitor, attractive current, ohm's law, ohm's etc. 2. Describe the purpose of simple circuit	1. Prepare the diagram of a simple electrical circuit 2. Prepare a simple electrical circuit for operating one lamp by one switch and 2 lamps by two switches. 3. Perform process to connect two or more lamps in a series (without live connection) 4. Demonstrate and perform the process to connect two or more lamps in parallel (without live connection)
6. Demonstrate staircase wiring	1. Describe the factors to be considered for planning and executing staircase wiring 2. Identify the tools and materials to be used for staircase wiring	1. Draw a diagram of the circuit for staircase wiring method 2. Demonstrate staircase wiring (without live connection)

LEARNING OUTCOMES	THEORY	PRACTICAL
7. Demonstrate godown wiring	<ol style="list-style-type: none"> 1. Describe the factors to be considered for planning and executing godown wiring 2. Identify the tools and materials to be used for staircase wiring 	<ol style="list-style-type: none"> 1. Draw a diagram of the circuit for godown wiring method 2. Demonstrate godown wiring method 3. Use the resources economically, safely and for intended purpose only
8. Demonstrate earthing	<ol style="list-style-type: none"> 1. Explain the purpose of earthing 2. Describe the materials used for earthing 3. Describe the precautions to be taken while earthing 4. Describe the meaning of good earthing 	<ol style="list-style-type: none"> 1. Identify the materials used in earthing 2. Draw a diagram for earthing 3. Demonstrate earthing installation by using appropriate materials and tools
9. Demonstrate fuse fitting	<ol style="list-style-type: none"> 1. Determine principle of fuse tripping 2. Describe different types of fuse wires 	<ol style="list-style-type: none"> 1. Demonstrate the use of different fuse wires
10. Recognize the main features of Miniature Circuit Breaker (MCB)	<ol style="list-style-type: none"> 1. Describe the purpose of MCB 2. Describe the main features of MCB 3. Describe safety factors involved in MCB 	<ol style="list-style-type: none"> 1. Demonstrate with explanation on the structure and working of MCB
11. Demonstrate soldering of basic electronics components using soldering iron	<ol style="list-style-type: none"> 1. Described purpose of soldering 2. Describe safety factors involved in soldering 3. Describe qualities of good soldering joint 	<p>Perform recognition of basic electronic component resistance, diode, transistors, and capacitors.</p> <ol style="list-style-type: none"> 1. Demonstrate soldering of basic electronics components using soldering iron
12. Maintain lead acid batteries, Measuring its specific gravity	<ol style="list-style-type: none"> 1. Describe various types of batteries and its comparison 2. Describe what is "specific gravity" and why is it important? 	<ol style="list-style-type: none"> 1. Demonstrate maintenance of lead battery and measuring of specific gravity
<p>13. Calculate monthly electricity unit consumption of a family using combination of lighting and kitchen equipment (blub, tubes, mixer, water heater etc.)</p> <p>14. Demonstrate knowledge of electricity saving measures.</p>	<ol style="list-style-type: none"> 1. Describe the unit of electricity and method to measure the consumption 	<ol style="list-style-type: none"> 1. Perform calculation of electricity bill for a given the load

LEARNING OUTCOMES	THEORY	PRACTICAL
15. Describe the advantages of different lighting solutions.	<ol style="list-style-type: none"> 1. Describe the different types of lights, their advantages and disadvantages. 2. Describe the benefits of using LED bulb 3. Estimate the cost 	<ol style="list-style-type: none"> 1. Perform reading wattage of bulb. 2. Select appropriate solution for required light. 3. Selecting appropriate
16. Recognize the various features of and describe the working principle of soak pit	<ol style="list-style-type: none"> 1. Explain the purpose and working principle of soak pit 2. Describe advantages and disadvantages of soak pit 3. Describe the applications of soak pit 	<ol style="list-style-type: none"> 1. Demonstrate and draw a diagram showing the various elements of soak pit 2. Perform the preparation of a soak pit
17. Identify the various types of garbage and explain the general procedures adopted for disposal of garbage in cities and rural areas	<ol style="list-style-type: none"> 1. Describe the various types of garbage and methods used for their disposal 2. Explain the purpose of garbage separation and its processing 3. State the various precautions to be taken when separating and processing garbage for Disposal 	<ol style="list-style-type: none"> 1. Demonstrate the knowledge of appropriate methods used for disposal of different types of garbage – biodegradable and non-biodegradable, toxic materials, infected materials, radioactive materials, etc.

UNIT 3 – GARDENING, NURSERY & AGRICULTURE TECHNIQUES (PART A)

LEARNING OUTCOMES	THEORY	PRACTICAL
<ol style="list-style-type: none"> 1. To learn to prepare land, or filling of pot 2. To learn to take one crop using agriculture tools and standard agri. practices. 	<ol style="list-style-type: none"> 1. To describe steps taken in taking one crop. 2. To describe principles behind the basic agricultural procedures. 	<ol style="list-style-type: none"> 1. Perform the growing one crop and do all tasks given below to achieve agriculture produce.
3. Calculate the amount of seed/plants for the area	<ol style="list-style-type: none"> 1. Describe the procedure for calculating the amount of seed/plant material for an area 	<ol style="list-style-type: none"> 1. Demonstrate the knowledge of calculating the amount of seed required for an area
4. Demonstrate to treating of seeds with traditional method/ biological agents/ chemicals/ fertilizers	<ol style="list-style-type: none"> 1. Describe precautions to be taken when selecting seeds 2. Describe advantages of seed treatment. 	<ol style="list-style-type: none"> 1. Perform the selection of seed treatment method for selected crop using krishi Diary. Perform seed surface treatment 2. Demonstrate to treat seeds with recommended method.

LEARNING OUTCOMES	THEORY	PRACTICAL
5. Perform planting of seeds and intercultural operations (weeding, fertilizer application, mulching etc.)	1. Describe the uses of various tools and equipment in intercultural operations (weeding, fertilizer application, mulching etc.)	1. Demonstrate the use of various tools and equipment in intercultural operations (weeding, fertilizer application, mulching etc.)
6. Prepare vermin composting and vermin wash	1. Describe use & advantages of vermin compost and vermin wash.	1. Demonstrate preparing of bed for Vermin composting. 2. Perform process to prepare bed for preparing vermin wash. 3. Perform the use of vermin compost and vermin wash in the plot.
7. Prepare organic pesticide formulation.	1. Describe procedure to make organic pesticide formulation. 2. Advantages of using organic pesticide.	1. Demonstrate organic preparing pesticide formulation. 2. Perform the process to apply them if there is a problem.

UNIT 3 – GARDENING, NURSERY & AGRICULTURE TECHNIQUES (PART B)

LEARNING OUTCOMES	THEORY	PRACTICAL
1. Determine the age of animals	1. Describe the methods of determining age of animals 2. Describe advantages of knowing age of the animal.	1. Process to determine the age of farming and milking animals
2. Determine the weight of animals to estimate feed requirement	1. Perform and describe the method of determining weight of animals and estimating feed requirement	1. Process to determine weight of animals by taking due precautions 2. Perform the calculation of fodder requirement of animal from TDN in different folder.
3. Understand different diseases of domesticized animals	1. Describe the different types of diseases observed in domesticized animals 2. Methods of identification of diseases	1. Process to identify different types of diseases. 2. Demonstrate methods of identification of different domesticated animals
4. Determine ability to estimate feed requirement for animals	1. Describe the method of determining the quantity of feed requirement of different types of animals.	1. Perform the calculation to estimate feed requirement of an animal by their age. 2. Perform the calculation to estimate of feed requirement of an animal by

LEARNING OUTCOMES	THEORY	PRACTICAL
	2. Describe the different types of feeds	their weight. 3. Perform the calculation to estimate feed requirement of a milk giving Animal
5. Determine yield of animal and its well-being	1. Describe the yield of animal according to geographical area 2. Describe different types of domesticized animals and their importance. 3. Describe how to ensure wellbeing of domesticized animals	1. Demonstrate method of determining yield of domesticized animal
6. Determine costing of Milk and milk products in a household business	1. Describe the process of costing of milk and milk products 2. Describe the difference between household business and commercial establishment	1. Perform the calculation for cost of milk 2. Perform the calculation for the cost of different types of milk products which can be produced in a household
7. Learn window / balcony gardening	1. Describe the process of window/balcony gardening	1. Describe the process of window/balcony gardening

UNIT 4 – FOOD PROCESSING TECHNIQUES

LEARNING OUTCOMES	THEORY	PRACTICAL
1. Able to prepare food items using safe and appropriate procedure.	1. Describe various methods of food preservation (salting, pickling, drying, smoking, preserving in brine water, etc.) 2. Describe principles behind basic preservation technique viz. use of high or low temperature, exclusion of air, removal of moisture, use of preservatives, etc. 3. Describe importance of maintaining hygiene in cooking area.	A) Demonstrate making of following food items as per the standard procedures given in following rows 1. Chikki 2. Sauce 3. Jam and Jelly 4. Dried product, roasted product viz. Papad, dried vegetables 5. Pickle 6. Biscuits 7. Popcorn B) Perform the calculation for the costing of these food items.

LEARNING OUTCOMES	THEORY	PRACTICAL
<p>2. Identify the basic characteristics of raw food materials and apply cleaning and sanitation method</p>	<ol style="list-style-type: none"> 1. Describe the basic characteristics of raw food materials 2. Describe the basic principles and practices involved in cleaning and sanitation in food processing operations 	<ol style="list-style-type: none"> 1. Perform and apply the basic principles and practices of cleaning and sanitation of food while preparing all above food product. 2. Demonstrate the use of personal clothing for working in food processing area such a headgear, apron, gloves, etc.
<p>3. Identify and handle utensils and equipment used in cooking and baking</p>	<ol style="list-style-type: none"> 1. Describe the safety precautions to be taken for using utensils and equipment (measuring cups, spoons, knife, cutting board, frying pan, grate, etc.) 	<ol style="list-style-type: none"> 1. Demonstrate the use of knife/mixer/oven/ stove / gas. 2. Identify various flavors and uses of various spices, herbs, grains and greens 3. Perform the cleaning of the utensils and work area after cooking
<p>4. Apply appropriate cooking methods for preparation of various culinary</p>	<ol style="list-style-type: none"> 1. Describe various methods of wet, dry and combination cooking methods 2. Read the names of vegetables, grains, spices, herbs, etc. used in preparation of culinary 	<ol style="list-style-type: none"> 1. Demonstrate and adapt small recipes and cooking methods to prepare dishes 2. Perform and apply fuel conservation methods 3. Perform the cleaning of the utensils and work area after cooking
<p>5. Identify food requirements of adolescent male and female</p>	<ol style="list-style-type: none"> 1. Describe daily food requirement (nutrient) of adolescent male and female 	<ol style="list-style-type: none"> 1. Prepare a diet chart to meet the nutrient requirements of adolescent male and female from locally available food
<p>6. To demonstrate understanding of information on the packaging label & packaging of food products.</p>	<ol style="list-style-type: none"> 1. Describe food label. 2. Describe advantages of different food packaging types. 3. Describe shelf life and factors affecting shelf life of food items. 	<ol style="list-style-type: none"> 1. Demonstrate on how to interpret food label 2. Perform process to take weight and packaging of food product using sealing method. 3. Identify various different food packets
<p>7. Demonstrate the knowledge of methods of identifying adulteration.</p>	<ol style="list-style-type: none"> 1. Describe the methods of assessing adulteration. 	<ol style="list-style-type: none"> 1. Demonstrate detection of adulteration in milk& its product with the use of lactometer and other appropriate technique 2. Demonstrate other method of detecting adulteration in other food products.

MULTI SKILL FOUNDATION COURSE (CODE NO- 416)

CLASS – X (SESSION 2021-2022)

Total Marks: 100 (Theory-50 + Practical-50)

	TERM	UNITS	NO. OF HOURS for Theory and Practical 200		MAX. MARKS for Theory and Practical 100
Part A	Employability Skills				
	Term 1	Unit 1 : Communication Skills-II	10		5
		Unit 2 : Self-Management Skills-II	10		
		Unit 3 : ICT Skills-II	10		
	Term 2	Unit 4 : Entrepreneurial Skills-II	15		5
		Unit 5 : Green Skills-II	05		
		Total	50		10
Part B	Subject Specific Skills		Theory (In Hours)	Practical (In Hours)	
	Term 1	Unit 1: Workshop and Engineering Techniques	35	15	20
		Unit 2: Energy and Environment	15	8	
	Term 2	Unit 2: Energy and Environment	15	7	20
		Unit 3: Gardening, Nursery & Agriculture Techniques	15	10	
		Unit 4: Personal Health and Hygiene	15	10	
			Total	95	55
Part C	Practical Work				
		Practical Examination			15
		Project			15
		Viva Voce			10
		Total			40
Part D	Student Portfolio				
		Practical File/ Student Portfolio	10		10
			Total		10
		GRAND TOTAL	200		100

DETAILED CURRICULUM/TOPICS FOR CLASS X:

Part-A: EMPLOYABILITY SKILLS

S. No.	Units	Duration in Hours
1.	Unit 1: Communication Skills-II	10
2.	Unit 2: Self-management Skills-II	10
3.	Unit 3: Basic Information and Communication Technology Skills-II	10
4.	Unit 4: Entrepreneurial Skills-II	15
5.	Unit 5: Green Skills-II	05
	TOTAL	50

NOTE: For Detailed Curriculum/ Topics to be covered under Part A: Employability Skills can be downloaded from CBSE website.

Part-B – SUBJECT SPECIFIC SKILLS

- Unit 1: Workshop and Engineering Techniques
- Unit 2: Energy and Environment
- Unit 3: Gardening, Nursery & Agriculture Techniques
- Unit 4: Personal Health and Hygiene

Unit 1 – Workshop & Engineering Section

LEARNING OUTCOMES	THEORY	PRACTICAL
1. Make any one of the following objects: Shoe stand, Candle stand, Hanger, Garbage collector, Tin box, Bangle stand using T-fillet joint, Open corner joint, Single V-butt joint	1. Describe safety precautions for making objects 2. Describe the various types of material that can be used for making objects	1. Demonstrate and prepare the design and drawing for the object 2. Demonstrate and made necessary measurement and marking as per the specifications 3. Students will observe & describe the process of welding carried out by the trainer for making the object as per the design & specification. (Students are not expected to carry out the process of welding but only observe by following due safety precautions) 4. Follow safety precautions 5. Demonstrate the use of personal protective clothing and equipment 6. Perform cleaning of the work area before and after the task 7. Process to calculate the cost of the article prepared

LEARNING OUTCOMES	THEORY	PRACTICAL
2. Carry out GI piping by carrying out treading, coupling two or more pipes using different fittings.	1. Describe use of different piping fitting used in GI piping.	1. Perform installation die in pipe wrench 2. Perform and adjusting pipe wrench for threading 3. Perform and carry out threading 4. Perform process to connect pipes using appropriate coupling.
3. Draw plan, elevation of simple objects (Cone, cylinder, cube)	1. Identify orthographic and isometric view. 2. Read and understand orthographic drawing and its dimension. 3. Able to interpret scale on the drawing.	1. Demonstrate and draw plan, elevation and side view of an object. 2. Perform selection of scale 3. Demonstrate and draw drawing using proper Line, lettering and system of giving dimensions in drawing.
4. Prepare a Ferro cement object (Sheet / tank) as per given specifications	1. Describe what is Ferro cement and state its applications 2. Describe advantages of Ferro cement. 3. Describe the safety precautions to be followed when preparing a Ferro cement structure	1. Demonstrate and perform the process to Construct a Ferro cement job, following relevant safety precautions 2. Demonstrate and perform the process to prepare mortar 3. Perform curing of job 4. Demonstrate and draw orthographic sketch of job with dimension. 5. Demonstrate and perform the process to do calculation for costing of job.
5. Prepare Reinforced Cement Concrete (RCC) column	1. Describe what is an RCC work and its applications. 2. Describe function of Torsion bar. 3. Describe safety precautions while constructing Reinforced Cement Concrete (RCC) work	1. Identify various materials used in Reinforced Cement Concrete (RCC) work 2. Perform Reinforced Cement Concrete (RCC) work to prepare column as per given specifications and following necessary safety precautions 3. Make wooden mold from plywood sheets 4. Cutting of torsion bar and bending of 6mm bar
6. Plaster & painting of the brick work of min 1 sq. meter.	1. Describe safety precautions while plastering with mortar 2. Describe the benefits of plastering 3. Describe the benefits of painting 4. Function of cement, sand and water	1. Demonstrate the use of personal protective clothing and equipment 2. Plaster an area of 1 sq. meter 3. Painting of wall

LEARNING OUTCOMES	THEORY	PRACTICAL
7. Prepare bill for the job.	<ol style="list-style-type: none"> 1. Describe difference between bills , estimate and quotation 2. Describe component of costing and basis for calculating sales price. 	<ol style="list-style-type: none"> 1. Calculate costing of job 2. Raise bill to customer

UNIT 2 – ENERGY & ENVIRONMENT

LEARNING OUTCOMES	THEORY	PRACTICAL
1. Prepare a simple electrical circuit	<ol style="list-style-type: none"> 1. Explain the meaning of various terms used in simple circuit such as electrical potential difference/ voltage, conductive path, electrical resistance potential difference, transistor, conventional current, direct current, capacitor, attractive current, ohm's law, ohm's etc. 2. Describe the purpose of simple circuit 	<ol style="list-style-type: none"> 1. Perform and prepare the diagram of a simple electrical circuit 2. Demonstrate to prepare a simple electrical circuit for operating one lamp by one switch and 2 lamps by two switches. 3. Demonstrate process to connect two or more lamps in a series 4. Demonstrate process to connect two or more lamps in parallel
2. Demonstrate the knowledge of the basic features and capacity of Inverter and its maintenance	<ol style="list-style-type: none"> 1. Describe the working principle of Inverter and state the various components of an inverter 2. Describe various maintenance needs and procedure to perform the maintenance 	<ol style="list-style-type: none"> 1. Identify various parts of an inverter 2. Determine inverter capacity for various combinations of electrical and electronic gadgets (e.g. two tube light and one fan) 3. Perform the maintenance of an Inverter
3. Demonstrate installation of DOL/starter to motor	<ol style="list-style-type: none"> 1. Describe purpose of DOL/Starter and how it works 	<ol style="list-style-type: none"> 1. Process to open DOL Starter 2. Perform process to connect DOL starter with the given motor 3. Perform a proper cable joint.
4. Demonstrate the understanding of motor / pump and its operation viz. Priming, foot valve etc.	<ol style="list-style-type: none"> 1. Describe various parts of motor/pump. 2. Demonstrate understanding of specification written on pump. Viz. Head/flow/HP 3. Describe the need of priming , foot valve, starter etc. 	<ol style="list-style-type: none"> 1. Demonstrate and carry out priming of motor. 2. Process to start the pump/motor.
5. Demonstrate the knowledge of functioning of solar lights and devices	<ol style="list-style-type: none"> 1. Explain the working principle of solar panel and solar devices (any one of solar cooker, solar heater, solar lamp, etc.) 2. Describe the advantages and limitations of the use of solar energy 	<ol style="list-style-type: none"> 1. Identify the various components of solar devices and gadgets (any one of solar cooker, solar heater, solar lamp, etc.) 2. Demonstrate the knowledge of functioning and maintenance of solar devices and gadgets (any one of solar cooker, solar heater, solar lamp, etc.)

LEARNING OUTCOMES	THEORY	PRACTICAL
6. Describe the functioning and operation of a Petrol or diesel Engine	<ol style="list-style-type: none"> 1. Describe the design and working principle of petrol or diesel engine 2. Describe the operation of petrol or diesel engine. 3. Describe the functioning of important parts like piston, spark plug, and cylinder. 	<ol style="list-style-type: none"> 1. Draw a diagram demonstrating the working of petrol or diesel engine. 2. Perform the process to start & stop diesel/petrol engine.
7. Demonstrate the knowledge of biogas.	<ol style="list-style-type: none"> 1. Describe the various components of Floating Dome Type and Fixed Dome Type Biogas Plants 2. Describe the basic principle involved in biogas production 3. Describe the working principle of biogas plant 	<ol style="list-style-type: none"> 1. Identify the various components of a biogas plant 2. Identify different types of feeds for biogas plant viz. cow dung, poultry litter, starchy biomass kitchen waste etc. 3. Draw and demonstrate a diagram of a biogas unit
8. Demonstrate making of charcoal using biomass	<ol style="list-style-type: none"> 1. Describe what is a biomass and examples of bio mass material 2. Describe the purpose of making charcoal from biomass 3. Describe steps to make charcoal from biomass 	<ol style="list-style-type: none"> 1. Demonstrate and perform the process to make charcoal out of locally available biomass material
9. Select site for rain Water harvesting	<ol style="list-style-type: none"> 1. Describe what is rainwater harvesting and why it is necessary 2. Describe what is a contour lines and what are they used for 3. Describe application of different survey instruments. 	<ol style="list-style-type: none"> 1. Demonstrate and perform the process to make "A" frame out of the local available wooden material 2. Find points on the ground which are at the same level and draw contour. 3. Perform the use plaint table/dumpy level to mark contours.
10. To make rain gauge & measure rainfall and understand weather parameters	<ol style="list-style-type: none"> 1. Describe why do we need to measure rainfall 2. Describe what are the different weather parameters 	<ol style="list-style-type: none"> 1. Demonstrate and perform the process to make a rain gauge using a plastic bottle and funnel 2. Perform the process to record the rainfall 3. Analyze the results 4. Analyze other weather parameters measurement from a secondary source (e.g. newspaper, TV)

UNIT 3 – GARDENING, NURSERY & AGRICULTURE TECHNIQUE (PART B)

LEARNING OUTCOMES	THEORY	PRACTICAL
1. Apply nursery techniques	<ol style="list-style-type: none"> 1. Describe the various components of a plant nursery 2. Describe the procedure of potting and repotting of plants 3. Describe the precautions to be taken when sowing seed/planting plant materials. 	<ol style="list-style-type: none"> 1. Identify various plants suitable for growing in nursery 2. Perform the preparation of seed bed/raised bed 3. Demonstrate and perform the process to sow seeds in propagation trays and seed bed 4. Perform the preparation of pots for growing plants 5. Perform potting 6. Perform De-potting 7. Demonstrate and perform the process to maintaining records of plant growth
2. Demonstrate the knowledge and application of different irrigation and water conservation methods	<ol style="list-style-type: none"> 1. Describe the advantages and limitations of various irrigation methods (surface, sprinkler, drip, basin, furrow, etc.) and water conservation methods (bund, rainwater harvesting, trenching etc.) 	<ol style="list-style-type: none"> 1. Identify various irrigation methods 2. Demonstrate and perform the process to installation and maintenance of drip/sprinkler irrigation system 2. Demonstrate and perform the process to various water conservation methods (bund, rainwater harvesting, trenching etc.)
3. Demonstrate the knowledge of interpreting results of soil testing	<ol style="list-style-type: none"> 1. Describe the importance and purpose of soil testing 2. Describe how to collect soil sample 3. List the methods used for testing nitrogen, phosphorus and potash in soil 	<ol style="list-style-type: none"> 1. Demonstrate the use of soil auger 2. Demonstrate the procedure for collecting soil sample for testing 3. Interpret the results of soil test for fertilizer application
4. Assist in artificial insemination	<ol style="list-style-type: none"> 1. Explain artificial insemination and its benefits 2. Describe the AI process 	<ol style="list-style-type: none"> 1. Identify breeds used for artificial insemination
5. Prepare fodder for animals	<ol style="list-style-type: none"> 1. Describe different fodder making techniques. 2. Advantages of giving particular type of fodder to cattle. 	<ol style="list-style-type: none"> 1. Perform a process to select best fodder for animal in the surrounding. 2. Carry out the procedure for preparing fodder. 3. Perform a process to maintain record and costing of fodder preparation and its effect.

UNIT 4 – PERSONAL HEALTH & HYGIENE

LEARNING OUTCOMES	THEORY	PRACTICAL
1. Identify the symptoms of nutrient deficiencies	<ol style="list-style-type: none"> 1. Describe the importance of balanced diet in health and wellness 2. Describe the advantages of being healthy (mental, physical and social wellness) 	<ol style="list-style-type: none"> 1. Identification of the symptoms of nutrient deficiencies 2. Identification on how families can influence personal health
2. Identify the personal health behaviors and factors affecting personal health	<ol style="list-style-type: none"> 1. Describe the importance of a healthy and safe environment. 2. Define the terms communicable (infectious) and non-communicable (noninfectious) diseases and identify ways that help to prevent diseases 3. List personal health behaviors (e.g. hand washing, teeth brushing, use of tissues, explaining feelings, making healthy food choices, daily physical activity) 4. Describe how families and peers can influence the health of adolescents 5. Describe Importance of vaccination & essential vaccines for a child. 	<ol style="list-style-type: none"> 1. Demonstrate and perform the process to Identify the personal health behaviors and factors affecting personal health 2. Demonstrate and perform the process to hand washing as per the standard procedure 3. Identify and practice ways to prevent disease and other health problems 4. Demonstrate and perform the process to maintain a wellness log including exercise and food intake for a particular period of time
3. Demonstrate the knowledge of identifying causes and treating dehydration	<ol style="list-style-type: none"> 1. Describe dehydration and its effect 2. Recognize physiological indicators (e.g., heart rate, body temperature, perspiration, thirst) of health and physical activity 	<ol style="list-style-type: none"> 1. Demonstrate and perform the process to identify symptoms of dehydration and take remedial measures. 2. Demonstrate and perform the process to prepare Oral Rehydration Salt (ORS) solution.
4. Demonstrate knowledge and measurement of blood pressure, hemoglobin count and identify blood group using self-administered kits	<ol style="list-style-type: none"> 1. Describe the importance of blood pressure 2. Describe the precautions to be taken while measuring blood pressure, hemoglobin count or identifying blood group 	<ol style="list-style-type: none"> 1. Determine blood pressure using blood pressure machine, measure hemoglobin count and identify blood group 2. Analyze the results <p>Students will observe & describe the process of blood group testing carried out by the trainer. (Students are not expected to carry out the process of blood group testing but only observe by following due safety precautions)</p>

LEARNING OUTCOMES	THEORY	PRACTICAL
5. Test quality of water using H ₂ O strip test	<ol style="list-style-type: none"> 1. Describe harmful ingredients in a contaminated water 2. Describe how to analyze results of water quality test 	<ol style="list-style-type: none"> 1. Perform water quality test using H₂O strip testing kit 2. Analyze the results
6. Identify various community services and programs	<ol style="list-style-type: none"> 1. Describe the needs of disadvantaged people, people with special needs, travelers, people affected with natural and manmade disasters, aged people, etc. 2. Describe need of preventive health care for maintaining personal health by calculating health expenses of family. 3. Describe emergency first aid help to needy. 	<ol style="list-style-type: none"> 1. Calculate medical / health expenses of a family in previous year. 2. Learn to use first aid kits in emergency.
7. Identify measures for pollution control and take appropriate action	<ol style="list-style-type: none"> 1. Explain different sources of pollution 2. Describe the effects of pollution on environment and on living beings 3. Describe different measures for prevention and control of pollution 	<ol style="list-style-type: none"> 1. Identify the sources of pollution 2. Identify the effects of pollution on environment and on living beings 3. Demonstrate the measures to control pollution
8. Identify food related issues and problems and take appropriate action	<ol style="list-style-type: none"> 1. Differentiate between fresh and stale food 2. Describe the advantages and disadvantages of loose and packed food 3. Describe how to handle and serve food for maintaining personal hygiene and health 	<ol style="list-style-type: none"> 1. Identify the hygienic practices/methods adopted for handling of food 2. Demonstrate the knowledge of safe transportation of food

TEACHING/TRAINING ACTIVITIES:

The teaching and training activities have to be conducted in classroom, laboratory/ workshops and field visits. Students should be taken to field visits for interaction with experts and to expose them to the various tools, equipment, materials, procedures and operations in the workplace. Special emphasis should be laid on the occupational safety, health and hygiene during the training and field visits.

CLASSROOM ACTIVITIES - Classroom activities are an integral part of this course and interactive lecture sessions, followed by discussions should be conducted by trained vocational teachers. Vocational teachers should make effective use of a variety of instructional aids, such as audio-video

materials, colour slides, charts, diagrams, models, exhibits, hand-outs, online teaching materials, etc. to transmit knowledge and impart training to the students.

PRACTICAL WORK IN LABORATORY/WORKSHOP - Practical work may include but not limited to hands-on-training, simulated training, role play, case based studies, exercises, etc. Equipment and supplies should be provided to enhance hands-on learning experience of students. Only trained personnel should teach specialized techniques. A training plan that reflects tools, equipment, materials, skills and activities to be performed by the students should be submitted by the vocational teacher to the Head of the Institution.

FIELD VISITS/ EDUCATIONAL TOUR - In field visits, children will go outside the classroom to obtain specific information from experts or to make observations of the activities. A checklist of observations to be made by the students during the field visits should be developed by the Vocational Teachers for systematic collection of information by the students on the various aspects. Principals and Teachers should identify the different opportunities for field visits within a short distance from the school and make necessary arrangements for the visits. At least three field visits should be conducted in a year.

SKILL ASSESSMENT (PRACTICAL) - Assessment of skills by the students should be done by the assessors/examiners on practical demonstration of skills by the candidate. The assessors assessing the skills of the students should possess a current experience in the industry and should have undergone an effective training in assessment principles and practices.

Practical examination allows candidates to demonstrate that they have the knowledge and understanding of performing a task. This will include hands-on practical exam, viva voce and student portfolio (File/journal).

Project Work (individual or group project) is a great way to assess the practical skills on a certain time period or timeline. Project work should be given on the basis of the capability of the individual to perform the tasks or activities involved in the project. Projects should be discussed in the class and the teacher should periodically monitor the progress of the project and provide feedback for improvement and innovation. Field visits should be organised as part of the project work. Field visits can be followed by a small-group work/project work. When the class returns from the field visit, each group might be asked to use the information that they have gathered to prepare presentations or reports of their observations. Project work should be assessed on the basis of practical file or student portfolio.

Student Portfolio is a compilation of documents that supports the candidate's claim of competence. Documents may include reports, articles, and photos of products prepared by students in relation to the unit of competency.

Viva voce allows candidates to demonstrate communication skills and content knowledge. Audio or video recording can be done at the time of viva voce. The number of external examiners would be decided as per the existing norms of the Board and these norms should be suitably adopted/adapted as per the specific requirements of the vocational subject. Viva voce should also be conducted to obtain feedback on the student's experiences and learning during the project work/field visits.

ORGANISATION OF FIELD VISITS:

In a year, at least 3 field visits/educational tours should be organised for the students to expose them to the activities in the workplace.

1) Visit a nursery available near their home or school. Instruct students to observe following points in the nursery.

Observation – Instruct students to classify and note down various plants available in the nursery in the table below:

Flowering Plants	Fruit Plants	Vegetables	Medicinal Plants	Ornamental Plants

Seedlings cultivated by sowing seeds (Seedlings cultivated in seedling trays)	Seedlings cultivated from branches	Seedlings cultivated by grafting	Seedlings cultivated in pots	Seedlings cultivated on ground	Seedlings cultivated in greenhouse

Instruct students to find answers for questions mentioned below, during field visit –

- Which sections were available in the nursery?
- What precaution is taken while planting seedlings in pots?
- What precaution is taken to prevent pests on seedlings?
- Which method is used in nursery to cultivate good quality seedlings on large scale?
- What is the approximate expense required to raise a seedling in a nursery?
- Which methods are used in a nursery for seeding or cultivating seedling?

2) Visit a nearby fuel station. Instruct them to inquire about the rate of petrol and diesel to a fuel station attendant. Instruct students to gather information about questions mentioned below -

- Which fuel is costlier? What is the reason behind it?
- Why diesel is used in some vehicles instead of petrol?
- How do few vehicles run on both fuels: petrol as well as diesel? Which fuel is environment-friendly?





LIST OF EQUIPMENT AND MATERIALS

The list given below is suggestive and an exhaustive list should be prepared by the teacher. Only basic tools, equipment and accessories should be procured by the Institution so that the routine tasks can be performed by the students regularly for practice and acquiring adequate practical experience.







Multi Skill Foundation Course (MSFC)
Job Role - Multi Skill Assistant Technician
List of Tools and Equipment – Grade 9th & 10th
Unit : Workshop and Engineering Technique









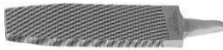

Notes:







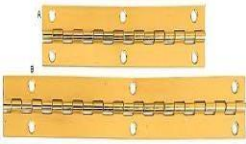

1. 12 to 15 students in one group and the group will be further divided in a group 4 to 5 students who will perform the same practical simultaneously.
2. Sequencing of the project / practical activities among the small groups of students will be necessary to facilitate the use of set of tools available.
3. The list below is arranged section wise / type wise to facilitate procurement of tools as well as stock taking / inventory.
4. Appropriate storage, foundation, as necessary, and display boards will have to be procured for proper storage, upkeep, and security of the tools and equipment. All the tools required for Grade 9th & 10th are listed below.

Sr. No	Name of Tool, Equipment	Picture	Specification
Measuring Equipments			
1	Steel Ruler		150 mm, 300mm, 1 meter
2	Measuring Tape		3 and 5 Meter
3	Spirit Level Bottle		0.01 - 0.05mm/meter
4	Vernier Calliper		150mm (LC/0.02mm) & 200mm (LC/0.05mm)



5	Spring Calliper Inside /Outside /Divider		6" or 150 mm Length Inside /Outside /Divider
6	Out - Side Micrometre		0-25mm (LC/0.01mm)
7	Threading Gauge (Engineering)		Metric
8	Threading Gauge (Plumbing)		British
9	Radius Gauge		Metric
10	Tri Square		75mmx100mm
11	Tri-square (Welding)		Blade size 150mm
12	Tri-Square (Casting base) (construction and Carpentry)		Blade Size 600mm
Carpentry Hand Tools/ Cutting Tools / Equipment			
13	Scriber		150 to 200 mm length with double ended - 1 Straight and 1 bend end.
Page 27 of 52			

14	Claw Hammer		400 gm Chrome Plated Claw Hammer Tubular Steel Handle: With Handle
15	Mallet Wooden		Small
16	Mallet Plastic		Medium
17	Tenon Saw		10"
18	Saw		18"
19	Saw small size		12"
20	Saw teeth setting plier		
21	Hacksaw Frame	 QR-0487	12", fix metal frame.
22	Half Round Wood rasp File		10"
23	Flat file Rasp		10"









24	Flat file Rough		12"
25	C-Clamps (for carpentry use)		4"
26	Iron Plane		5" & 9"
27	Firmer Chisel		Flat, Width 1" & 1/2", Length - 8" with Plastic Handle
28	Mortise Chisel		Width 1/4" & 1/2" Length -8" with Plastic handle
29	Pairing Chisel		Width 1" Length -8" with Plastic handle
30	Hand Drill Machine		
31	Butt Hinges		Width-50mm, Length -100 mm
32	Rising Butt Hinges		Width-50mm, Length -100 mm
33	T' hinges		Width-50mm, Length -100 mm

34	Parliament hinge		Width-50mm, Length -100 mm
35	Piano Hinges		Width-50mm, Length -100 mm
36	Sun mica Cutter		
37	Carboundum Stone (Emery)		6" x 2.5" x 2"
38	Auger Bit		1/4" & 1/2"
Sheet-Metal Work Hand Tools/ Cutting Tools /Equipment			
39	Tin Cutter (Tin cutter with spring)		Small size 12"
40	Tin Cutter -Scissor		12"
41	Blow Lamp		
42	Soldering Iron		Copper









Drilling, Tapping, Threading Hand Tools/ Cutting Tools /Equipment









43	Bench Drill Machine (With belt safety guard & on/off switch facility)		Capacity: 13mm 230V 50Hz , single phase
44	HSS Drill set		4 Mm To 13 Mm
45	Centre Drill		2.5 - 6.5 mm 90 डग्री
46	Tap Wrench		200 mm
47	Oil Can		250 ml
48	Machine vice		100 mm Jaw opening
49	Hammers B.P (Hammers ball pain)		500 Grams
50	Hammer C.P (hammer cross pain) with handle forged steel		500 Grams
51	Flat Chisel		6"







52	File Handle Wooden		
53	Flat Basted File		10",12"
54	Flat Smooth File		12"
55	Triangular files		10"
56	Round Basted File		8"
57	Bench Grinder		Wheel Diameter 150 Mm, single phase, 1/2 HP, 230v-50 Hz,
58	Electrical hand drill machine		13 mm, Fiber Body Drill Machine, KPT
59	Bench Vice (Code-U -301)		Jaw lenght-100mm,
60	Open End Wrench/ Spanner SET		6mm-18mm(Sizes mm: 6X7, 8X9, 10X11, 12X13, 14X15, 16X17,)
61	Ring Spanner Set		6-7 To 20-22 Mm

62	Tap & Die Set		6 mm To 12 mm
63	Die wrench		Length 300mm, ID 38mm
Welding Hand Tools/ Cutting Tools /Equipment			
64	Arc Welding Machine (Transformer)		250Amp / single phase (portable machine)
65	Cable & Lugs (Welding cable)		5 Meter (welding cable for 250 amp)10 sq. mm. { 3 Meter for Holder & 2 Meter for Earthing
66	Welding / Electrode Holder		Plastic Handle
67	Wire Brush		
68	Adjustable Wrench (Adjustable Spanner)		10"
69	Grip-on-pliers		100mm
70	Vise Grip		7"

Building & Construction Hand/ Cutting Tools /Equipment

71	Trowel Set		Full set with different sizes
72	Trowel -Plane		Plane sheet for finishing
73	Plumb Bob		Metal
74	Line Rope		15 meter/1 bundle
75	Sand Sieve		1.5ft diameter
76	Masonry Drill (Concrete Drill)		5 mm To 12 mm(5 No)
77	Bucket (MS steel bucket)		Iron 10 liter G.I Bucket
78	Ghamela (MS Steel) (for construction work)		MS steel / plastic for construction work
79	Spade with wooden handle		

Plumbing Hand Tools/ Cutting Tools /Equipment			
80	Pipe Die Set - with D/E Handle(pipe wrench)		1/2" , 3/4" , 1"
81	Pipe Vice		3" Cap
82	Pipe Wrench		12"
83	Water Pump Plier		10"
84	Hack Saw Blade		12" (300mm)
Safety Equipment			
85	Safety Helmet		Medium size PVC
86	Safety Goggle		Medium
87	Welding Goggle		
88	Welding Screen with Head Band		

89	Overcoat (Apron-Blue colour)		small and Medium size (Blue colour)
90	Hand Gloves (Welding leather hand gloves)		small Size (leather)
91	Cotton Hand Gloves (sheet metal work)		Small Size (Cloth)
92	Hand gloves pairs (constriction)		
93	Welding Apron		
94	Rubber Chappals		Medium Size (14-16 age) Small and Medium
95	First Aid Box		Cotton, Adhesive Bandage, Gauze roll bandage, Scissor, Dettol, Antiseptic cream- Soframycin.

Storage and Working Table



Sr.No	Particular	Dimensions' with details	Specification
1	Cupboard for Storage of tools	Steel file cabinet with 4 adjustable shelves with lock and key facility, 20 Gauge with 78" x 34 " 19 " (6'6" x 2'10" x 1'7")	6ft- Steel Cupboard
2	Display board for tools display and easy access to students	Water Proof ISI Mark plywood with 18mm thickness, For screw drivers, testers to display and easy access	4ftX2ft Plywood with 18mm thickness











3	Working Table is needed to perform practical's for 15 students	Length : 5ft, Breadth : 3 ft Height : 30 Inch Top : 18 Mm commercial ply with 1, Lamination, bottom should be rubber leveller	Steel MS Angle frame with wooden Top ; L shape 35/5 with grey paint
4	Table for installation of Machine	Length : 4 ft. Breadth : 3ft Height : 30 Inch Top : 18 Mm commercial ply with 1, Lamination, bottom should be rubber leveller	4FtX3ftX2.5ft Steel frame with wooden top / Power coating grey paint

Multi Skill Foundation Course (MSFC)
Job Role - Multi Skill Assistant Technician
List of Tools and Equipment - Grade 9th & 10th
Unit : Energy and Environment



Notes:

- 12 to 15 students in one group batch and the group will be further divided in a group 4 to 5 students who will perform their same practical simultaneously.
- Sequencing of project/ practical activities among the small group of students will be necessary to facilitate the use of set of tools available.
- The list below is arranged section wise / type wise to facilitate procurement of tools as well as stock taking / inventory.
- Appropriate storage, foundation, as necessary, and display boards will have to be procured for proper storage, upkeep, and security of the tools and equipment.





Sr. No.	Name of the Tool / Equipment	Picture	Specification
Measuring Devices			
1	Voltmeter		10 to 500 V
2	Ammeter		0 to 50 amp
3	Wattmeter		0 to 1500 W

4	Frequency Meter		05 to 65 Hz
5	Voltmeter / DIGITAL MULTIMETER		
6	Non-contact Voltage Detector		
7	Wire Gauge		
8	Hydro Meter		to check gravity for Acid battery
9	Fish Tape		up to 15ft
10	Linesman Pliers (Combination Pliers)		8"
11	Long Nose Pliers		6"
12	Side Cutting Player		6"
13	Screw Driver Set		100, 150, 200, 250, 300 mm
14	Screw Driver Set / Electrician-Wiremen Set		
15	Poker		

16	Tester		
17	Wire Stripper		
18	Razor Blade Knife (Utility Knife)		
19	Hack Saw		
20	3 Core Flexible Cable (For Drilling , Grinding , Welding M/c connecting)		1.5 Sq mm
21	Sockets (Assorted) 2 Pin		2 Pin
22	Sockets (Assorted) 3 Pin		3 Pin
23	Plugs (Assorted) Top 2 Pin		2 Pin
24	Plugs (Assorted) Top 3 Pin		3 Pin
25	Switches		
26	Switches (Assorted) One way		

27	Switches (Assorted) Two way		
28	Bell Push Switch		
29	Lamp Holders (Assorted) Angle		
30	Lamp Holders		
31	Light Emission Diode		
32	Pull-Push Switch		
33	Fluorescent Tube Light Set		40 watt
34	Capacitor		1000uF 25V ±20% Tolerance +105°C Max Temperature.
35	Relay		
36	Earthing Plate		1 ft. X 1ft.
37	Earthing Rod		
38	Earthing Pipe		

39	Different Type of Fuse		
40	Miniature Circuit Breaker		
41	Electric Soldering Iron		35 watt
42	Valve Spanner		
43	Nozzle/Nipple spanner		
44	Wick Stove		
45	Pressure Stove		
46	DOL STARTER		Single Phase, 230 Volt
47	WATER PUMP 1 PHASE		Single Phase , 0.5 HP
48	MOTER ELECTRIC 1 PHASE		Single Phase , 230 volt
49	Rotary Switch		
50	Earthing Wire		11 Gauge







51	Electric Wires		1 sq. mm
Safety Tools and equipment			
52	Electrical Hand Gloves		11 KVA
53	Rubber Matting		3' x 2'
54	Sand Bucket		10 Litre
55	Fire Extinguisher CO2		2kg, ABC Types
Storage and Working Table for students			
Sr.No.	Particular	Dimensions with details	Specification
1	Cupboard for Storage of tools	with lock and key facility	6ft- Steel Cupboard
2	Display Board	For screw drivers etc. for tools display and easy access, Water Proof ISI Mark plywood	4ftX2ft Plywood with 18mm thickness
3	Working Table is needed to perform practical's for 15 students	Wooden working table	Steel frame with wooden Top
4	Stools for sitting	Length : 12 Inch Breadth : 12 inch Height : 20 Inch Top : Perforated sheet with gauge, Steel Frame : 20 mm x 20 mm x 18 Gauge square tube with powder coating in grey paint, bottom should be rubber leveller	12"x12x20" Top : Perforated sheet with 18 gauge









Multi Skill Foundation Course (MSFC)
Job Role - Multi Skill Assistant Technician
List of Tools and Equipment – Grade 9th & 10th









Unit : Food Processing Techniques & Personal Health and Hygiene





Notes:









1. 12 to 15 students in one group batch and the group will be further divided in a group 4 to 5 students who will perform their same practical simultaneously.
2. Sequencing of project/ practical activities among the small group of students will be necessary to facilitate the use of set of tools available.
3. The list below is arranged section wise / type wise to facilitate procurement of tools as well as stock taking / inventory.
4. Appropriate storage, foundation, as necessary, and display boards will have to be procured for proper storage, upkeep, and security of the tools and equipment.







Sr. No.	Name of the Tool / Equipment	Picture
General Tools		
1	Stainless steel Plates	
2	Sieves	
3	Set of cooking spoon	
4	Stainless steel Containers with Cover (Pot)	
5	Steel Bowls	
6	Frying Pan (medium)	

7	Grater/ Shredder	
8	Hand Operated Chikki Slicer (Roller), cutter	
9	Knives	
10	Roller	
11	Gas lighter	
12	Measuring Mug / Cup	
13	Measuring Spoons	
14	Mixer (Mixture- Grinder)	
15	Pressure Cooker	

16	Scissors	
17	Table Spoons	
18	Single Burner Stove	
19	Tong	
20	Vegetable Peeler	
21	Water Container (Jug)	
22	Hindalium container with lid - 3 lit	
23	Dust Pan	
24	Sieves	

25	Plastic Container	
26	Glass container	
27	Kitchen Balance	
28	Plastic Bucket	
29	Plastic Dustbin	
30	Blood Pressure Measuring Equipment (Sphygmomanometer)	
31	Stethoscope	
32	Thermometer	
33	Weighing machine	

34	First -aid Box	
35	Beaker	
36	Digital BP machine	
37	Digital timer	
38	Candy Thermometer (for taking food temperature)	
39	Wall clock	
40	Fire Extinguisher CO2	
41	Apron (Cloth)	
42	Dish towels	

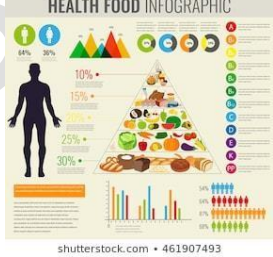
43	Hand Gloves	
44	Hand Gloves (Plastic)	
45	Head Caps (Cloth)	
46	Candles	
47	Aluminium foil	
CHARTS		
48	Food Pyramid	
49	Nutrition Chart	

50	Diseases Chart	
----	----------------	---

Storage and Working Tables for students

Sr.No.	Particular	Dimensions with details	Specification
1	Cupboard for Storage of tools	Steel file cabinet with 4 adjustable shelves with lock and key facility, 20 Gauge with 78" x 34" 19" (6'6" x 2'10" x 1'7")	6ft- Steel Cupboard
2	Kitchen Table with Drawer and Storage cupboard / Working table	Length : 5ft Breadth : 3ft Height : 30 Inch Steel Frame : 20 mm x 20mm Square tube with 18 gauge , legs rubber bush, colour grey with powder coating. Top: GI Top with sink frame with sink _ keep empty space below sink. One drawer with lock and key facility and two shelves with two door and half closed from all side. Frame: Steel MS Angle; L shape 35/5 with grey paint.	5ftx3ftx2.5 steel frame with steel top
3	Stools for sitting	Length : 12 Inch Breadth : 12 inch Height : 20 Inch Top : Perforated sheet with 18 gauge, Steel Frame : 20 mm x 20 mm x 18 Gauge square tube with powder coating in grey paint , bottom should be rubber leveller (Nylon)	12"x12x20" Top : Perforated sheet with 18 gauge
4	Display Board/Notice Board	for tools display and easy access, Water Proof ISI Mark plywood	4ftX2ft Plywood with 18mm thickness





Consumables









Consumables will be required to be procured as per the need of the Practical.

Multi Skill Foundation Course (MSFC)
Job Role - Multi Skill Assistant Technician
List of Tools and Equipment – Grade 9th & 10th
Unit : Basics of Agriculture & Animal Husbandry Techniques

Notes:





1. 12 to 15 students in one group batch and the group will be further divided in a group 4 to 5 students who will perform their same practical simultaneously.
2. Sequencing of project/ practical activities among the small group of students will be necessary to facilitate the use of set of tools available.
3. The list below is arranged section wise / type wise to facilitate procurement of tools as well as stock taking / inventory.
4. Appropriate storage, foundation, as necessary, and display boards will have to be procured for proper storage, upkeep, and security of the tools and equipment. At the end of the list, additional tools for urban schools are prescribed.
5. Green Highlighted tools indicate as a consumable.

Sr. No.	Name of the Tool, Equipment	Picture
General Tools		
1	Budding Knife	
2	Garden Knife	
3	Grafting Knife	
4	Hori Knife (Soil Knife)	
5	Tree Cutting Shears	

6	Pruning Sheared / C Cutter	
7	Pruning Knife	
8	Trowels	
9	Spade with wooden Handle	
10	Axe with wooden handle	
11	Pickaxe with wooden handle	
12	Hand Digging Trowel	
13	Sickle	
14	Leaf Rake	
Page 51 of 52		

15	Scissor	
16	Watering Can, 8 to 10 Litre.	
17	Plastic Ghamela	
18	Crate	
19	Plastic Jar - 500 ml (Mug)	
20	Plastic Buckets , 10 Litre	
21	Spraying Pump	
22	Measuring Tape	
23	Weighing Balance	
Page 52 of 52		

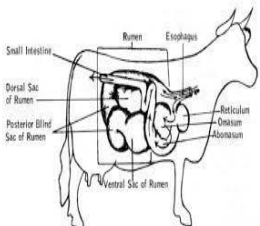
24	Animal Digital Thermometer	
25	Magnifying lens(bi-concave lens)	
26	Seeding Trays for Nursery ?(70 Cavity / holes)	
27	Sprinkler Irrigation Unit (Lateral pipe 16mm x 20ft , Micro sprinkler & micro jet 05 no's each)	
28	Drip Irrigation Unit (Lateral pipe 16mm x 20 ft. , Elbow , coupler , T-joint , mini valve, end cap , drip punch 5nos each	
29	Grafting transplanting bags	
30	Lactometer	
31	Measuring Cylinder	

32	Beaker	
33	Hand Gloves (Long)	
34	Mask (Canvas Mask)	
CHARTS		
35	Irrigation method charts	
36	Artificial insemination Chart	
37	Breed charts Cow, Goat ,Bullock	
Storage and Working Tables for students		
Sr.No	Name of the Tool / Equipment	Dimensions with details

1	Cupboard for Storage of tools	Steel file cabinet with 4 adjustable shelves with lock and key facility, 20 Gauge with 78" x 34 " 19 " (6'6" x 2'10" x 1'7")
2	Display board for tools display and easy access to students	Water Proof ISI Mark plywood with 18mm thickness, For screw drivers, testers to display and easy access
3	Working Table is needed to perform practical's for 15 students	Wooden working table with Stools for 12/15 students
Consumables		
Consumables will be required to be procured as per the need of the practical.		