

SECTION A

1. It is independent of the distance. It's a straight line parallel to x-axis. (1)

2.

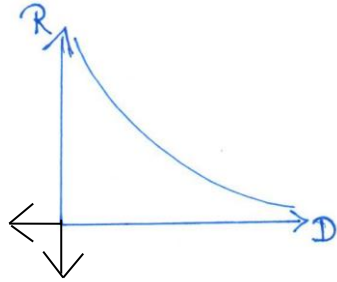

3. $\varepsilon = Blv$ (1/2)
 $= B \cos \theta \times l \times (2gH)^{1/2}$ (1/2)

4. $I = I_0/2 \cos^2 (45)$ (1/2)
 $= I_0/4$ (1/2)

5.

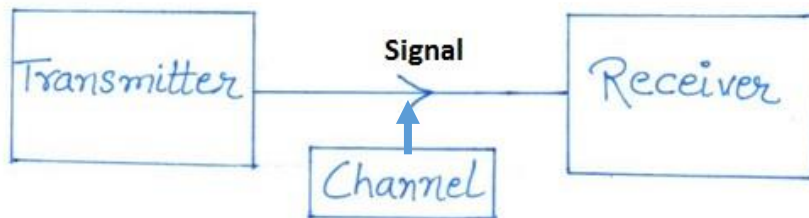

(1)

SECTION B

6.

$$A_A / A_B = 6 \quad (1/2)$$

$$H = V^2 t / R \quad (1/2)$$

$$R = \rho l / A \quad (1/2)$$

$$H_A / H_B = 6 \quad (1/2)$$

7.

$$1/f = (\mu - 1) [1/R_1 - 1/R_2] \quad (1/2)$$

$$1/20 = \frac{1}{2} [1/R_1 - 1/R_2] = \quad (1/2)$$

$$1/f' = \frac{1}{4} [1/R_1 - 1/R_2] \quad (1/2)$$

$$f' = 40 \text{ cm} \quad (1/2)$$

OR

$$P = +5D \quad f = 1/5 \text{ m} = 20 \text{ cm} \quad (1/2)$$

For 3rd observation, when the object is at $< 2f$, (1/2)

then the image has to be at $> 2f$ (1/2)

hence this observation is wrong. (1/2)

8.

$$m_p = 1u \quad m_\alpha = 4u \text{ and } q_p = e \quad q_\alpha = 4e \quad (1/2)$$

$$\frac{1}{2} m v^2 = qV \quad (1/2)$$

$$P = mv = [\sqrt{2qVm}]^{1/2} \quad (1/2)$$

$$P_p / P_\alpha = 1/8 \quad (1/2)$$

9.

a) $t_{1/2} = 0.693 / 1.05 = 39.6$ or approx. 40 min (1/2)

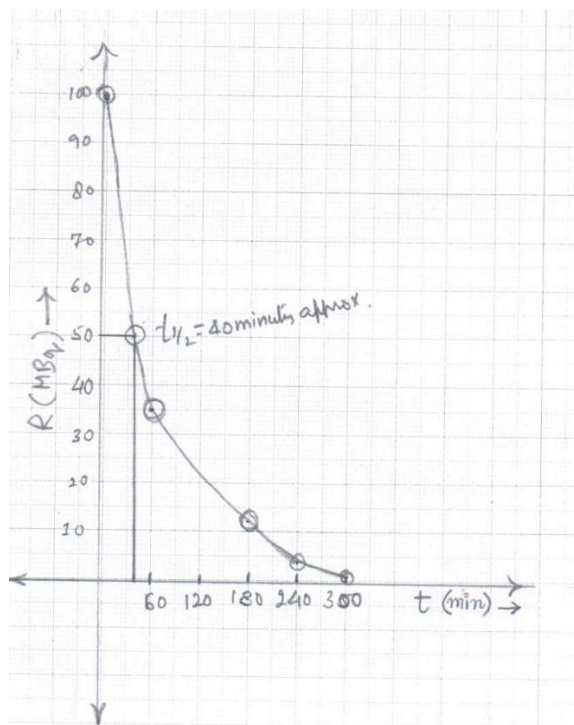

(1/2)

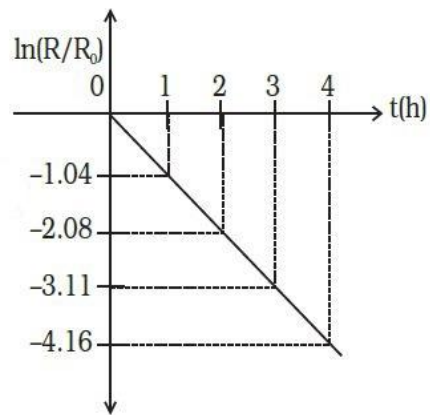

b) slope of graph = $-\lambda$

$$\lambda = - [-4.16 + 3.11 / 1] = 1.05 \text{ h} \quad (1/2)$$

$$t_{1/2} = 0.693 / 1.05 = 39.6 \text{ or approx. } 40 \text{ min} \quad (1/2)$$

10.

Any correct answer 1 mark each

SECTION C

11.

a) $Q = \pm N q$ (1)

b) $V = Q/C$ $v = q / c$ $V / v = N (r/R) = N^{2/3}$ (1)

c) $C = N^{1/3} c$ (1)

12.

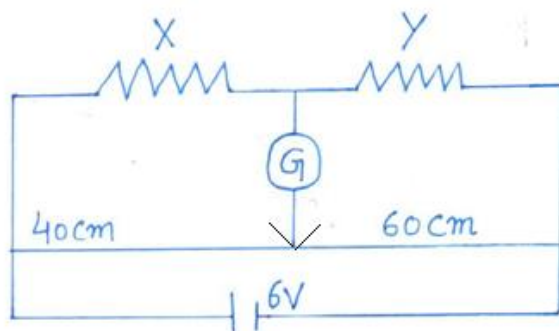

$$X/Y = 40/60 = 2/3$$

$$X = 4 \Omega \quad (1/2)$$

4 Ω and 6 Ω are in series, = 10 Ω

40 Ω and 60 Ω are in series, = 100 Ω

10 Ω and 100 Ω are in parallel, = $1000/110 \Omega = 9.09 \Omega$ (1)

There will be no change in the balancing length. (1/2)

Formula for series and parallel (1/2) each

OR

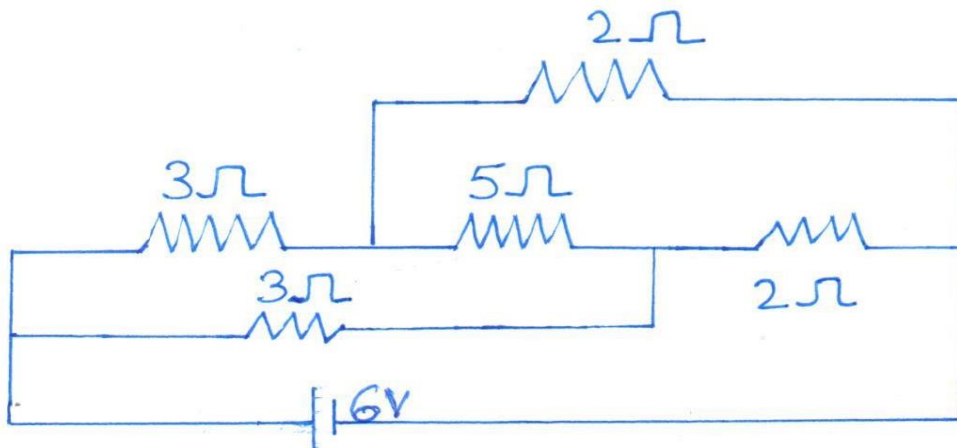

Balanced Wheatstone bridge (1/2)

Resultant resistance of the circuit = 2.5 Ω (1/2)

Current in the circuit = $6/2.5 = 2.4 \text{ A}$ (1)

Statement and conservation of energy (1/2) each.

13.

Rate of change of flux = $d\Phi/dt = (\pi l^2) B_0 l dz/dt = IR$ (1/2)

$$I = (\pi l^2 \lambda) B_0 v / R \quad (1/2)$$

Energy lost per second = $I^2 R = (\pi l^2 \lambda)^2 B_0^2 v^2 / R$ (1/2)

Rate of change in PE = $m g dz/dt = m g v$ (1/2)

$$mgv = (\pi l^2 \lambda)^2 B_0^2 v^2 / R \quad (1/2)$$

$$v = mgR / (\pi l^2 \lambda)^2 B_0^2 \quad (1/2)$$

14.

a) In absence of magnetic field, the energy is determined by the principle quantum number n , while the orbital quantum number l . If an electron is in n th state then the magnitude of the angular momentum is $(h/2\pi) l(l+1)$ where $l = 0, 1, 2, \dots, (n-1)$. Since $l = 0, 1, 2, \dots, (n-1)$, different values of l are compatible with the same value of n . For example, when $n = 3$, the possible values of l are 0, 1, 2, and when $n = 4$, the possible values of l are 0, 1, 2, 3. Thus, the electron in one of the atoms could have $n = 3, l = 2$, while the electron in the other atom could have $n = 4, l = 2$. Therefore, according to quantum mechanics, it is possible for the electrons to have different energies but have the same orbital angular momentum.

b)

For a point nucleus in H-atom:

$$\text{Ground state: } mvr = h, \frac{mv^2}{r_B} = -\frac{e^2}{r_B^2} \cdot \frac{1}{4\pi\epsilon_0}$$

$$\therefore m \frac{h^2}{m^2 r_B^2} \cdot \frac{1}{r_B} = + \left(\frac{e^2}{4\pi\epsilon_0} \right) \frac{1}{r_B^2}$$

$$\therefore \frac{h^2}{m} \cdot \frac{4\pi\epsilon_0}{e^2} = r_B = 0.51 \text{ \AA}$$

If $R \gg r_B$: the electron moves inside the sphere with radius r'_B ($r'_B =$ new Bohr radius).

$$\text{Charge inside } r'_B = e \left(\frac{r_B^3}{R^3} \right)$$

(1)

$$\therefore r'_B = \frac{h^2}{m} \left(\frac{4\pi\epsilon_0}{e^2} \right) \frac{R^3}{r'^3_B}$$

$$r'^4_B = (0.51 \text{ \AA}) \cdot R^3 \quad R = 10 \text{ \AA}$$

$$= 510(\text{\AA})^4$$

$$\therefore r'_B = (510)^{1/4} \text{ \AA} < R.$$

$$K.E = \frac{1}{2} m v^2 = \frac{m}{2} \cdot \frac{h^2}{m^2 r'^2_B} = \frac{h^2}{2m} \cdot \frac{1}{r'^2_B}$$

$$= \left(\frac{h^2}{2m r_B^2} \right) \cdot \left(\frac{r_B^2}{r'^2_B} \right) = (13.6 \text{ eV}) \frac{(0.51)^2}{(510)^{1/2}} = \frac{3.54}{22.6} = 0.16 \text{ eV}$$

(1)

$$P.E = + \left(\frac{e^2}{4\pi\epsilon_0} \right) \cdot \left(\frac{r'^2_B - 3R^2}{2R^3} \right)$$

$$= + \left(\frac{e^2}{4\pi\epsilon_0} \cdot \frac{1}{r_B} \right) \cdot \left(\frac{r_B (r'^2_B - 3R^2)}{R^3} \right)$$

$$= +(27.2 \text{ eV}) \left[\frac{0.51(\sqrt{510} - 300)}{1000} \right]$$

$$= +(27.2 \text{ eV}) \cdot \frac{-141}{1000} = -3.83 \text{ eV.}$$

(1)

15.

$E/B = v$ when E , V and B are perpendicular to each other. (1)

Cyclotron, E is perpendicular to B is perpendicular to V , In presence of E parabolic path and in presence of B circular path. T and V are independent of radius of the path. (1)

When frequency of oscillator is same as frequency of cyclotron then resonance occurs. (1)

16.

$$T_2P = D + x, T_1P = D - x$$

$$S_1P = \sqrt{(S_1T_1)^2 + (PT_1)^2}$$

$$= [D^2 + (D - x)^2]^{1/2}$$

$$S_2P = [D^2 + (D + x)^2]^{1/2}$$

Minima will occur when

$$[D^2 + (D + x)^2]^{1/2} - [D^2 + (D - x)^2]^{1/2} = \frac{\lambda}{2}$$

$$\text{If } x = D$$

$$[D^2 + 4D^2]^{1/2} = \frac{\lambda}{2}$$

$$(5D^2)^{1/2} = \frac{\lambda}{2}, \therefore D = \frac{\lambda}{2\sqrt{5}}$$

17.

Diagram (1)

$L = \text{length of the telescope} = f_o + f_e = 15.05 \text{ m}$ (1)

$m = f_o/f_e = 15/0.05 = 300$ (1)

18. A - Incident energy is less than the work function of the metal (1)

B - Incident energy is equal to the work function of the metal (1)

C - Incident energy is greater than the work function of the metal (1)

19.

Proton

alpha particle

e

2e

1 u

4 u

$$r = mv/Bq$$

For same momentum: $p = mv$ $r \propto 1/q$ (1)

$R(\text{proton}) > r(\text{alpha})$ (1/2)

For same kinetic energy: $KE = \frac{1}{2} m v^2$ (1)

$$r^2 \propto m/q^2$$

Radius is independent of KE (1/2)

20. a)

$$E = h \mu \quad (1/2)$$

$$= hc/\lambda = hc / \lambda e \quad (1/2)$$

$$= 2 \text{ eV} \quad (1/2)$$

Hence D₁ and D₃ can detect light. (1/2)

b)

Number of Free electrons are very small leading to negligible conduction.
Hence not possible. (1)

21.

As $V_{be} = 0$, potential drop across R_b is 10V.

$$\therefore I_b = \frac{10}{400 \times 10^3} = 25 \mu A$$

Since $V_{ce} = 0$, potential drop across R_c , i.e. $I_c R_c$ is 10V.

$$\therefore I_c = \frac{10}{3 \times 10^3} = 3.33 \times 10^{-3} = 3.33 \text{ mA}$$

$$\therefore \beta = \frac{I_c}{I_b} = \frac{3.33 \times 10^{-3}}{25 \times 10^{-6}} = 1.33 \times 10^2 = 133.$$

22. a)

μ is kept less than 1 so that the noise level can be kept small in the (1) signal.

b)

$$\mu = a(\text{max}) + a(\text{min}) / a(\text{max}) - a(\text{min}) = 18/12 = 9/6 = 3/2 = 1.5 \quad (1)$$

c)

Fading of a signal is prominent in case of amplitude modulation and (1)
hence noise level is more in AM than FM

SECTION D

- 23.
- i) Any one relevant value (1)
 - ii) Nuclear fission (1)
 - iii) Fuel, moderator, cadmium rods, any two (1)
 - iv) to slow down the speed of neutrons (1)

SECTION E

- 24.
- $U = \frac{1}{2} CV^2$ (2)
 - Loss in energy (2)
 - It appears in the form of heat. (1)

OR

- Diagram (1/2)
 - Net force = 0 no translator motion (1/2)
 - Defination of torque (1/2)
 - SI unit (1/2)
 - troque = $pE \sin \theta$ (1)
 - $C_{eq} = 11/6 C$ (1/2)
 - where $C = A \epsilon_0/3d,$ (1/2)
 - $C1 = C, C2 = C/2, C3 = C/3$ (1/2)
 - and all of these capacitors are connected in parallel. (1/2)
25. a)
- $X_C = X_L$ (2)
- b)
- $I_o = V_o / \sqrt{(R^2 + X_L^2)}$ (1/2)
 - $V_o = \sqrt{2} V_{rms}$ (1/2)
 - $X_L = 2\pi fL$ (1/2)

$$I_0 = 15.54$$

(1/2)

Current lags behind the voltage by phase Φ

(1/2)

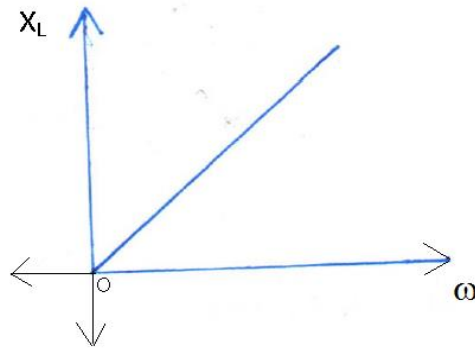

(1/2)

OR

a)

$$V = V_0 \sin \omega t \quad V = Q/C$$

(1/2)

$$I = dQ/dt$$

(1/2)

$$I_0 = V_0 / (1/\omega C)$$

(1/2)

$$I = I_0 \sin (\omega t + \pi/2)$$

(1/2)

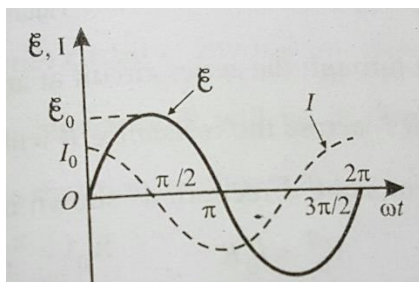

(1)

b)

$$X_c = 1 / 2\pi f c = 212.3 \Omega$$

$$Z = \sqrt{R^2 + X_c^2} = 291.5 \Omega$$

(1/2)

$$I_{rms} = v_{rms} / Z = 220 / 291.5 = 0.755 A$$

(1/2)

$$V_R(rms) = 151 V \quad V_c(rms) = 160.3 V$$

(1/2)

Two voltages are out of phase. Hence they are added vectorially and hence the difference is! (1/2)

26. a)

$$\mu = c/v = \sin i / \sin r, \quad (1)$$

$$v \propto \sin r \quad \text{Hence } v_{\min} \text{ for light will be for } r = 15^\circ. \quad (1)$$

Diagram (1)

derivation (1 1/2)

final expression (1/2)

OR

a. The ray coming from the object has to pass from denser to rarer medium and angle of incidence is greater than the critical angle.

(1+1)

b.

$$\text{i) } \sin c = n_1 / n \quad (90 - r_1) + 45 + (90 - c) = 180$$

$$r_1 = 45 - c \quad (1/2)$$

$$\begin{aligned} \sin i / \sin r_1 = n \quad \sin i &= n \sin r_1 = n \sin (45 - c) \\ &= n (\sin 45 \cos c - \cos 45 \sin c) \\ &= n/\sqrt{2} (\cos c - \sin c) \quad (1/2) \\ &= n/\sqrt{2} (\sqrt{1 - \sin^2 C} - \sin c) \\ &= 1/\sqrt{2} (\sqrt{n^2 - n_1^2}) - n_1 \end{aligned}$$

$$i = \sin^{-1} (1/\sqrt{2} (\sqrt{n^2 - n_1^2}) - n_1) \quad (1/2)$$

$$\text{ii) } r_2 = 0 \quad r_1 + r_2 = 45 \quad r_1 = 45 \quad (1/2)$$

$$\sin i / \sin r_1 = n$$

$$\sin i = n \sin r_1 = 1.352 \sin 45 = 0.956 \quad (1/2)$$

$$i = \sin^{-1} (0.956) = 72.58 \quad (1/2)$$